

INFORMATIVO TÉCNICO

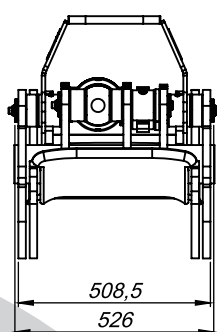
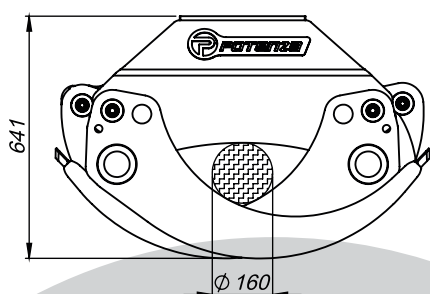
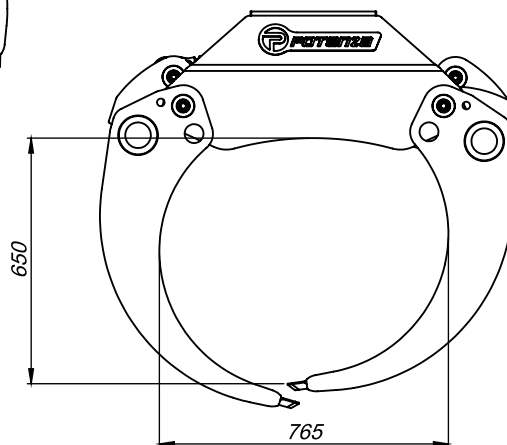
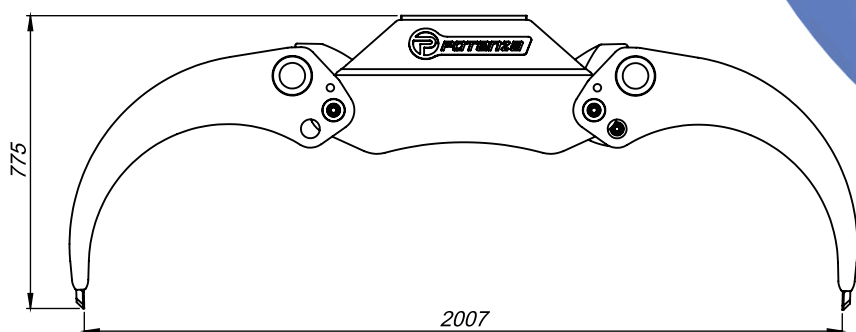

DADOS TÉCNICOS

Área da Garra	0,40 m ²
Peso	312 kg
Carga Máxima	5.500 kg
Força Fechamento Nominal do Cilindro @ 210 bar	9.500 kgf

PRESSÃO MÁXIMA DE TRABALHO

Garra Abrindo	150 kgf/cm ²
Garra Fechando	190 kgf/cm ²