

INFORMATIVO TÉCNICO

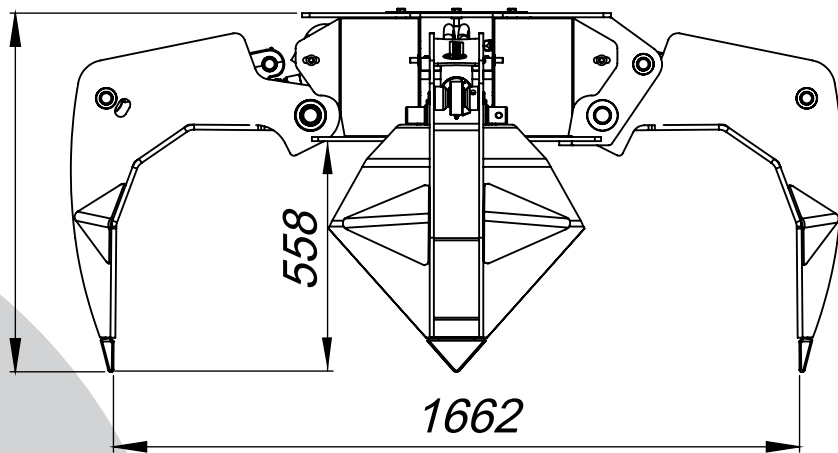
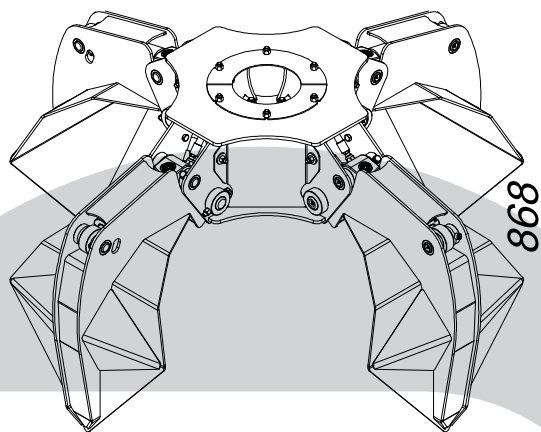
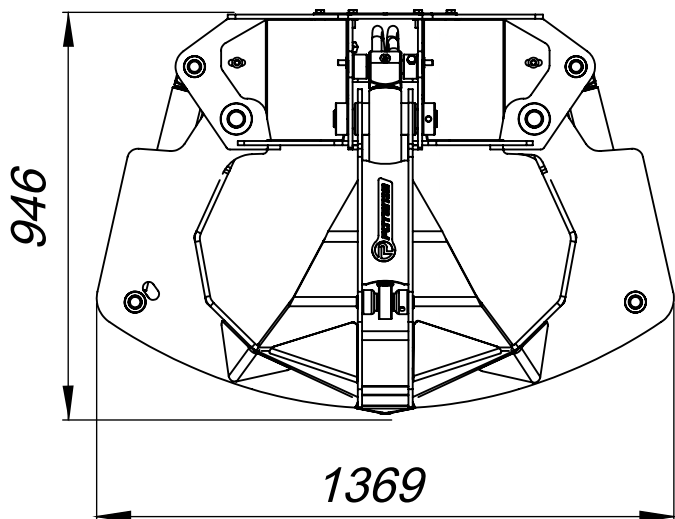
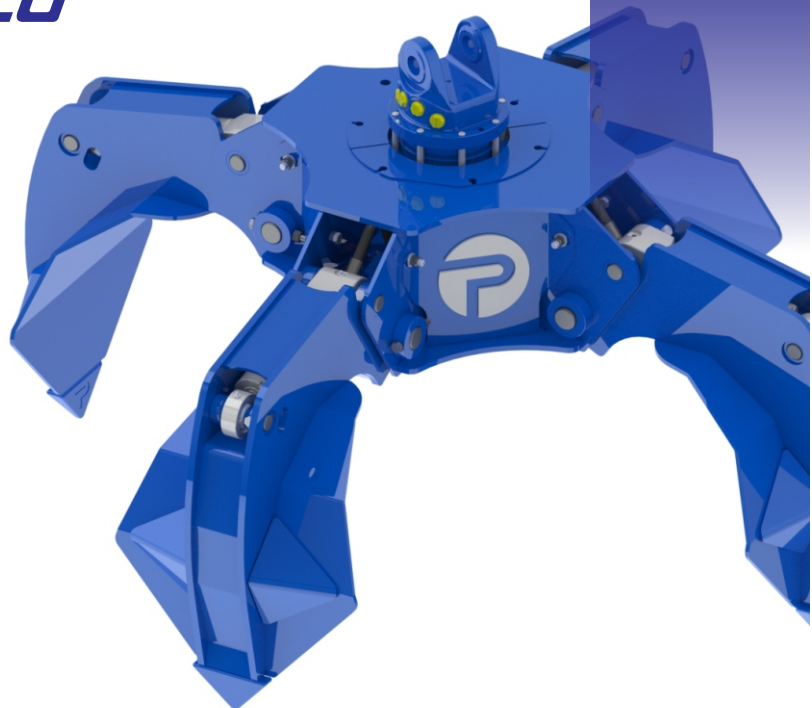

DADOS TÉCNICOS

Capacidade	300 litros
Peso	420 kg
Carga Máxima	2.500 kg
Pressão de Trabalho (máx.)	270 bar
Nº. de unhas	4