

**INFORMATIVO TÉCNICO**

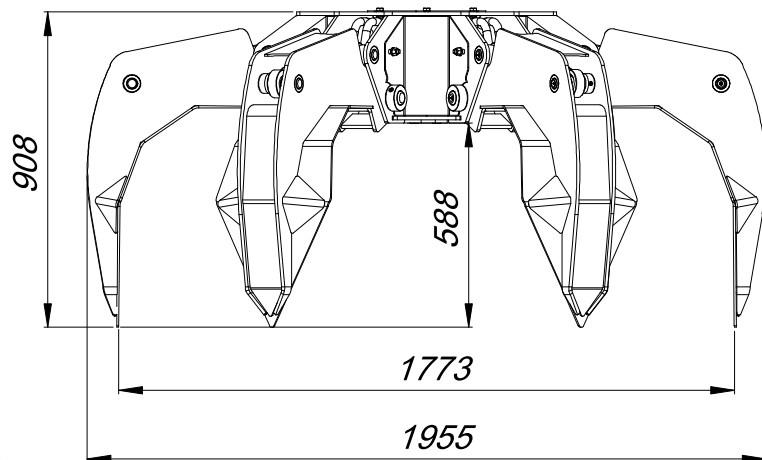
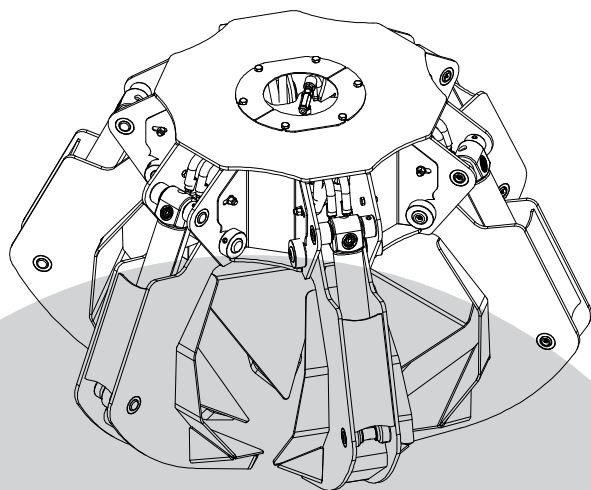
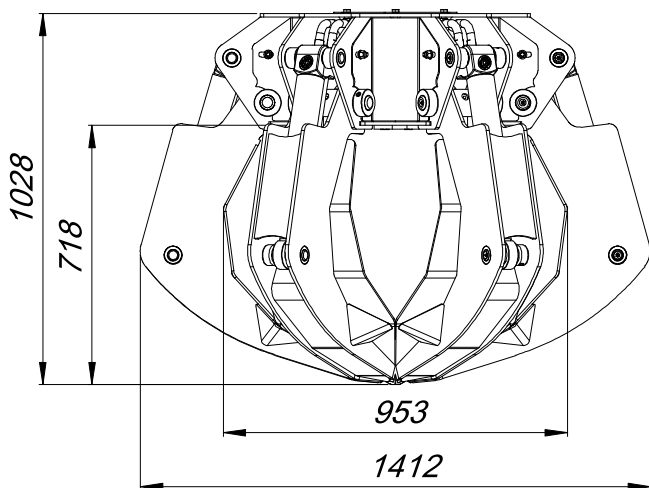

**DADOS TÉCNICOS**

Capacidade	300 litros
Peso	580 kg
Carga Máxima	2.500 kg
Pressão de Trabalho (máx.)	270 bar
Nº. de unhas	6